

SIZE	DIAMETER "D"	RADIUS "R"	WALL THICKNES	PART NUMBER	WEIGHT (LBS.)
4"	4.5"	48"	.096"	FGHW-42248	7.1196
5"	5.563"	48"	.110"	FGHW-52248	10.344
6"	6.625"	48"	.110"	FGHW-62248	14.9344
8"	8.625"	48"	.125"	FGHW-82248	22.585

DEEP SOCKET S/40 PVC COUPLING

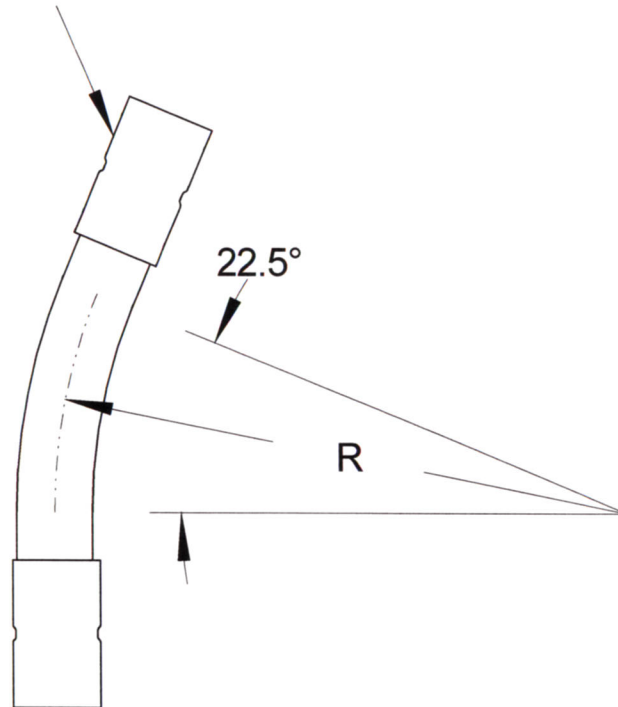

DEEP SOCKET PVC COUPLINGS CONFORM TO UL 651 SPECIFICATIONS

**RACEWAYS TECHNOLOGY
& MFG., INC.**

TACOMA, WA

22.5 DEGREE FIBERGLASS ELBOW 48" RADIUS
(HEAVY WALL)

NO SCALE

RTP

2012