

DEEP SOCKET PVC COUPLING

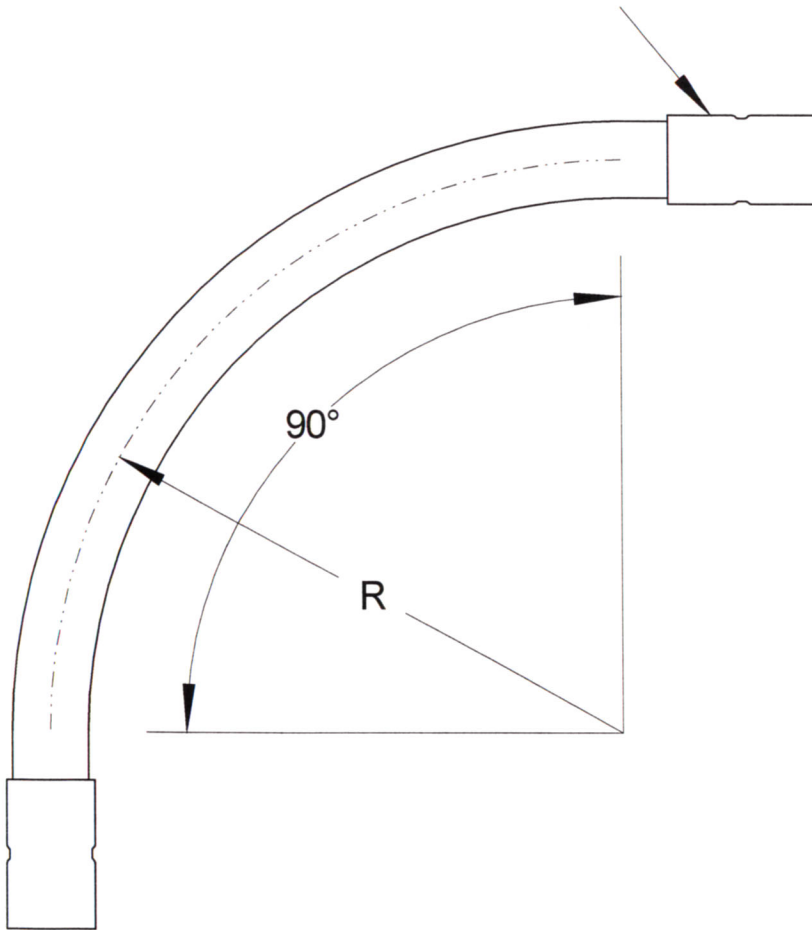

SIZE	DIAMETER "D"	RADIUS "R"	WALL THICKNES	PART NUMBER	WEIGHT (LBS.)
1/2"	.84"	48"	.070"	FGSW-059048	1.3552
3/4"	1.05"	48"	.070"	FGSW-0759048	1.4982
1"	1.315"	48"	.070"	FGSW-19048	1.719
1 1/4"	1.66"	48"	.070"	FGSW-1259048	2.223
1 1/2"	1.9"	48"	.070"	FGSW-1509048	3.146
2"	2.375"	48"	.070"	FGSW-29048	3.836
2 1/2"	2.875"	48"	.070"	FGSW-2509048	4.937
3"	3.5"	48"	.070"	FGSW-39048	7.353
4"	4.5"	48"	.070"	FGSW-49048	9.89
5"	5.563"	48"	.070"	FGSW-59048	13.474
6"	6.625"	48"	.070"	FGSW-69048	17.77
8"	8.625"	48"	.096"	FGSW-89048	31.518

DEEP SOCKET PVC COUPLINGS CONFORM TO UL 651 SPECIFICATIONS

**RACEWAYS TECHNOLOGY
& MFG., INC.**

TACOMA, WA

90 DEGREE FIBERGLASS ELBOW 48" RADIUS
(STANDARD WALL)

NO SCALE

RTP

2012