

ALL S/40 CONDUIT ELBOWS AND SWEEPS MANUFACTURED BY RACEWAYS TECHNOLOGY ARE MADE FROM ETL OR UL LISTED PVC PIPE TO UL 651 SPECIFICATIONS.

SIZE	DIAMETER "D"	RADIUS "R"	TANGENT "T" (MIN.)	PART NUMBER	WEIGHT (LBS.)
1/2"	.84"	12"	1.5"	S40-059012	0.317
3/4"	1.05"	12"	1.5"	S40-0759012	0.416
1"	1.315"	12"	1.875"	S40-19012	0.633
1 1/4"	1.66"	12"	2"	S40-1259012	0.91
1 1/2"	1.9"	12"	2"	S40-1509012	1.089
2"	2.375"	12"	2"	S40-29012	1.445
2 1/2"	2.875"	12"	3"	S40-2509012	2.296

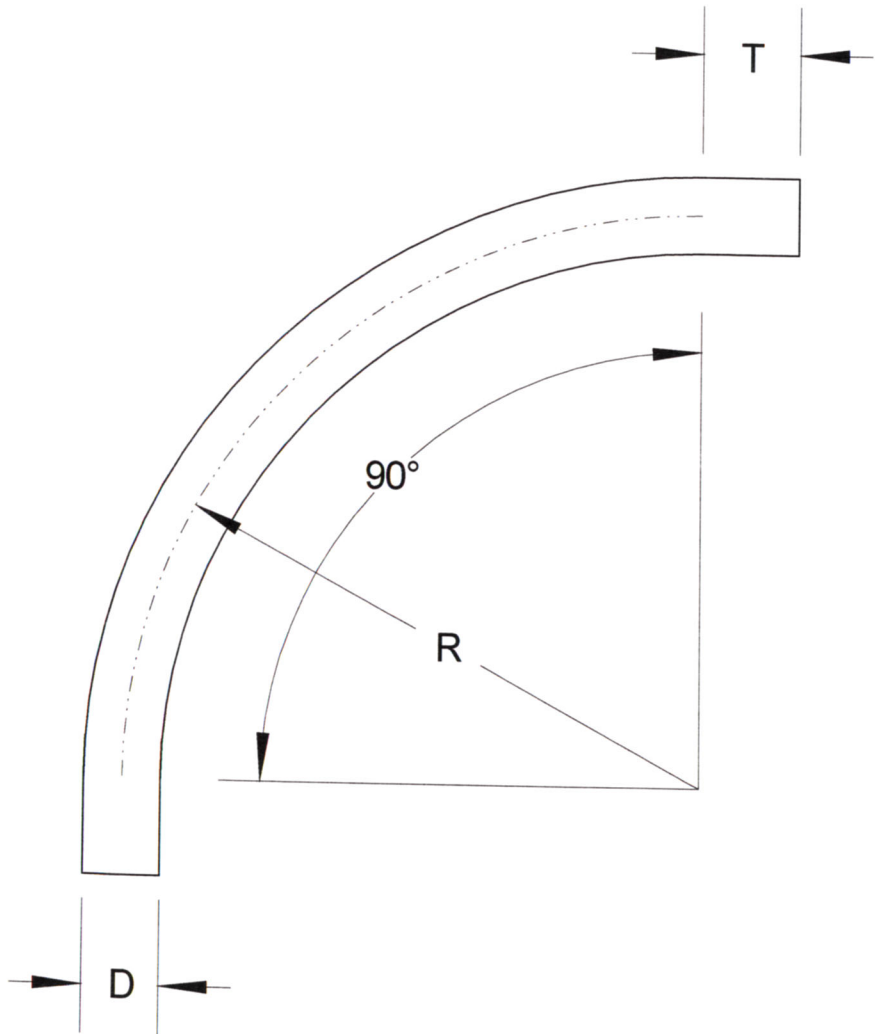

INTEGRAL COUPLINGS AVAILABLE ON REQUEST
 INTEGRAL COUPLINGS CONFORM TO UL 651 SPECIFICATIONS

**RACEWAYS TECHNOLOGY
 & MFG., INC.**
 TACOMA, WA

90 DEGREE S/40 PVC ELBOW 12" RADIUS

NO SCALE

RTP

2012