

SIZE	DIAMETER "D"	RADIUS "R"	TANGENT "T" (MIN.)	PART NUMBER	WEIGHT (LBS.)
1/2"	.84"	48"	1.5"	S40W-051148	0.195
3/4"	1.05"	48"	1.5"	S40W-0751148	0.252
1"	1.315"	48"	1.875"	S40W-11148	0.378
1 1/4"	1.66"	48"	2"	S40W-1251148	0.504
1 1/2"	1.9"	48"	2"	S40W-1501148	0.594
2"	2.375"	48"	2"	S40W-21148	0.796
2 1/2"	2.875"	48"	3"	S40W-2501148	1.295
3"	3.5	48"	3.125"	S40W-31148	2.06
4"	4.5"	48"	3.375"	S40W-41148	2.931
5"	5.563"	48"	3.625"	S40W-51148	5.403
6"	6.625"	48"	3.75"	S40W-61148	7.053
8"	8.625"	48"	6.625"	S40W-81148	11.93

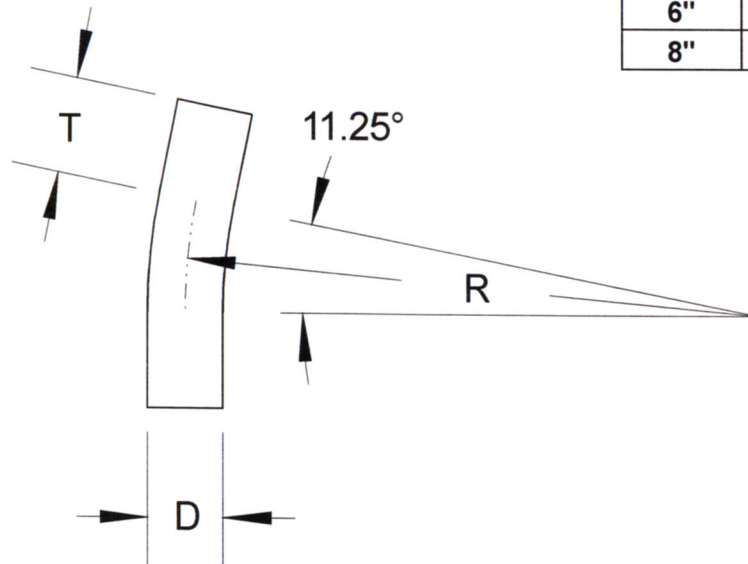

INTEGRAL COUPLINGS AVAILABLE ON REQUEST

**RACEWAYS TECHNOLOGY
& MFG., INC.**
TACOMA, WA

11.25 DEGREE S/40 NSF PVC ELBOW 48" RADIUS

NO SCALE

RTP

2012