

SIZE	DIAMETER "D"	RADIUS "R"	TANGENT "T" (MIN.)	PART NUMBER	WEIGHT (LBS.)
1/2"	.84"	60"	1.5"	S40W-051160	0.209
3/4"	1.05"	60"	1.5"	S40W-0751160	0.27
1"	1.315"	60"	1.875"	S40W-11160	0.406
1 1/4"	1.66"	60"	2"	S40W-1251160	0.541
1 1/2"	1.9"	60"	2"	S40W-1501160	0.637
2"	2.375"	60"	2"	S40W-21160	0.854
2 1/2"	2.875"	60"	3"	S40W-2501160	1.389
3"	3.5	60"	3.125"	S40W-31160	2.429
4"	4.5"	60"	3.375"	S40W-41160	3.456
5"	5.563"	60"	3.625"	S40W-51160	5.688
6"	6.625"	60"	3.75"	S40W-61160	7.667
8"	8.625"	60"	6.625"	S40W-81160	13.77

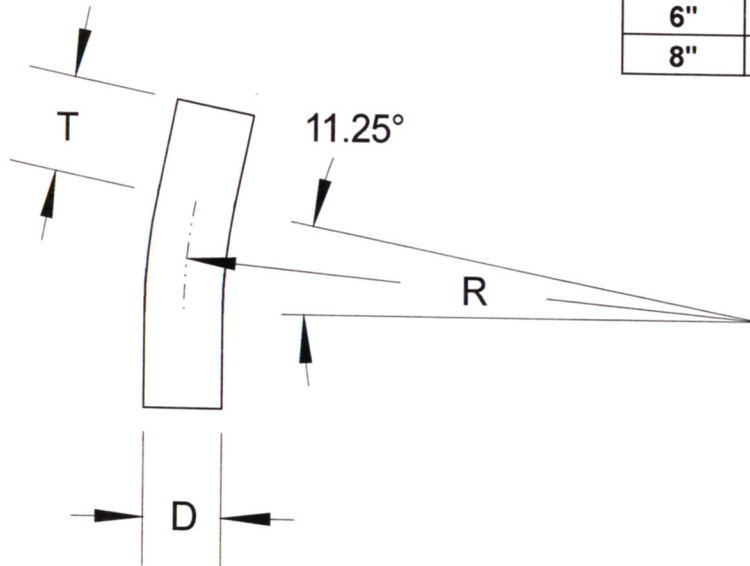

INTEGRAL COUPLINGS AVAILABLE ON REQUEST

**RACEWAYS TECHNOLOGY  
& MFG., INC.**  
TACOMA, WA

11.25 DEGREE S/40 NSF PVC ELBOW 60" RADIUS

NO SCALE

RTP

2012