

SIZE	DIAMETER "D"	RADIUS "R"	TANGENT "T" (MIN.)	PART NUMBER	WEIGHT (LBS.)
1/2"	.84"	48"	1.5"	S40W-059048	1.13
3/4"	1.05"	48"	1.5"	S40W-0759048	1.462
1"	1.315"	48"	1.875"	S40W-19048	2.193
1 1/4"	1.66"	48"	2"	S40W-1259048	2.924
1 1/2"	1.9"	48"	2"	S40W-1509048	3.443
2"	2.375"	48"	2"	S40W-29048	4.619
2 1/2"	2.875"	48"	3"	S40W-2509048	7.51
3"	3.5	48"	3.125"	S40W-39048	9.31
4"	4.5"	48"	3.375"	S40W-49048	13.956
5"	5.563"	48"	3.625"	S40W-59048	19.11
6"	6.625"	48"	3.75"	S40W-69048	27.523
8"	8.625"	48"	6.625"	S40W-89048	42.228

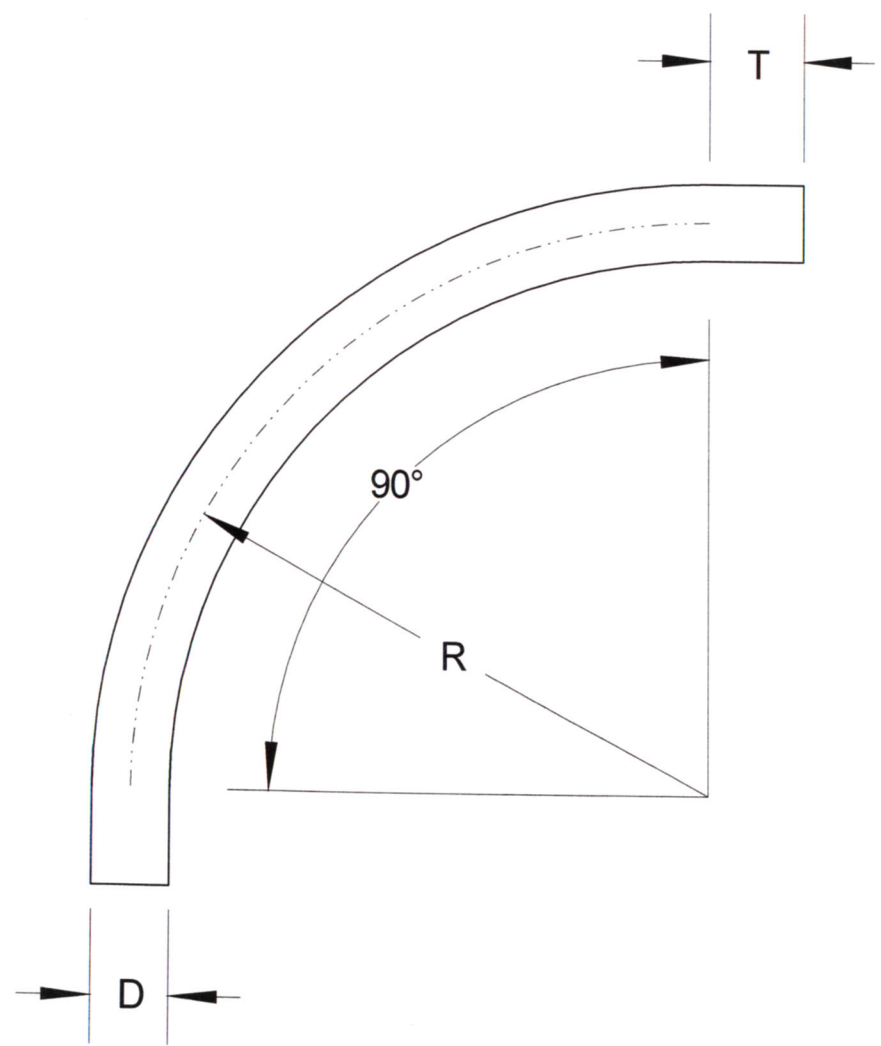

INTEGRAL COUPLINGS AVAILABLE ON REQUEST

**RACEWAYS TECHNOLOGY
& MFG., INC.**
TACOMA, WA

90 DEGREE S/40 NSF PVC ELBOW 48" RADIUS

NO SCALE	RTP	2012
----------	-----	------