

ALL S/80 CONDUIT ELBOWS AND SWEEPS MANUFACTURED BY RACEWAYS TECHNOLOGY ARE MADE FROM ETL OR UL LISTED PVC PIPE TO UL 651 SPECIFICATIONS.

SIZE	DIAMETER "D"	RADIUS "R"	TANGENT "T" (MIN.)	PART NUMBER	WEIGHT (LBS.)
1/2"	.84"	48"	1.5"	S80-052248	0.416
3/4"	1.05"	48"	1.5"	S80-0752248	0.554
1"	1.315"	48"	1.875"	S80-12248	0.831
1 1/4"	1.66"	48"	2"	S80-1252248	1.128
1 1/2"	1.9"	48"	2"	S80-1502248	1.366
2"	2.375"	48"	2"	S80-22248	1.9
2 1/2"	2.875"	48"	3"	S80-2502248	2.89
3"	3.5	48"	3.125"	S80-32248	3.879
4"	4.5"	48"	3.375"	S80-42248	5.66
5"	5.563"	48"	3.625"	S80-52248	9.842
6"	6.625"	48"	3.75"	S80-62248	13.536

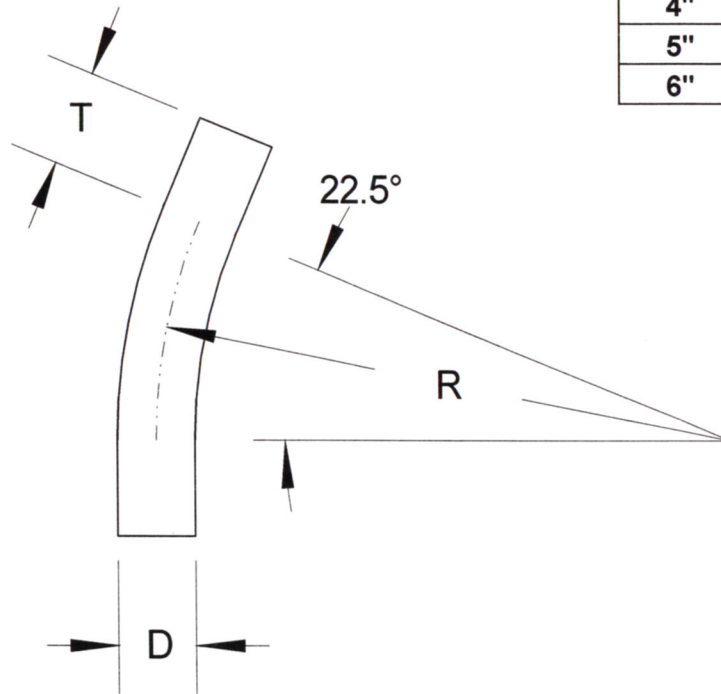

INTEGRAL COUPLINGS AVAILABLE ON REQUEST  
INTEGRAL COUPLINGS CONFORM TO UL 651 SPECIFICATIONS

**RACEWAYS TECHNOLOGY  
& MFG., INC.**  
TACOMA, WA

22.5 DEGREE S/80 PVC ELBOW 48" RADIUS

NO SCALE

RTP

2012