

SIZE	DIAMETER "D"	RADIUS "R"	TANGENT "T" (MIN.)	PART NUMBER	WEIGHT (LBS.)
2"	2.375"	36"	2"	S40B-22236	1.201

INTEGRAL COUPLING

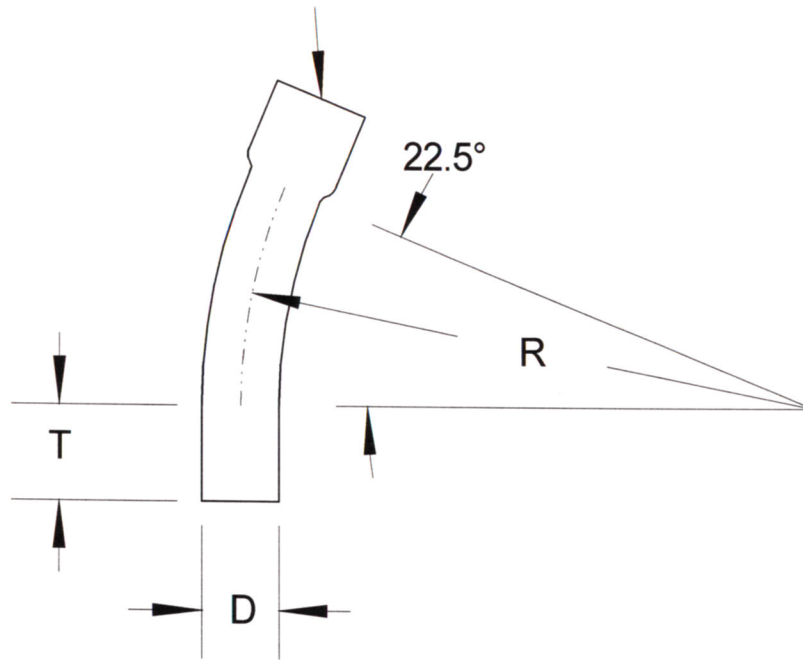

**RACEWAYS TECHNOLOGY
& MFG., INC.**

TACOMA, WA

22.5 DEGREE S/40 BUFF PVC ELBOW 36" RADIUS

NO SCALE

RTP

2012