

SIZE	DIAMETER "D"	RADIUS "R"	TANGENT "T" (MIN.)	PART NUMBER	WEIGHT (LBS.)
4"	4.35	72"	3.25	CD-42272	5.022

INTEGRAL COUPLING

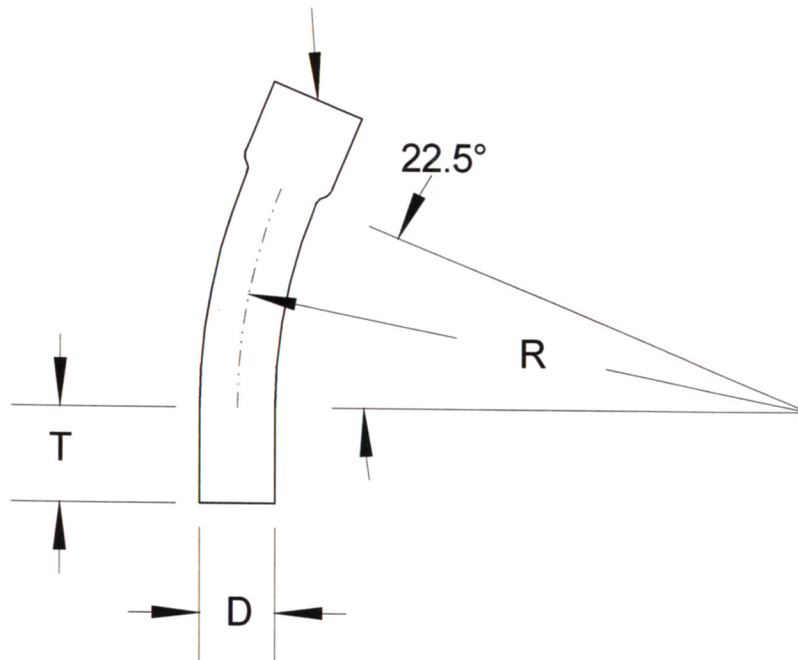

**RACEWAYS TECHNOLOGY  
& MFG., INC.**  
TACOMA, WA

22.5 DEGREE C-DUCT PVC ELBOW 72" RADIUS

NO SCALE

RTP

2012