

SIZE	DIAMETER "D"	RADIUS "R"	TANGENT "T" (MIN.)	PART NUMBER	WEIGHT (LBS.)
4"	4.35	60"	3.25	CD-43060	6.2

INTEGRAL COUPLING

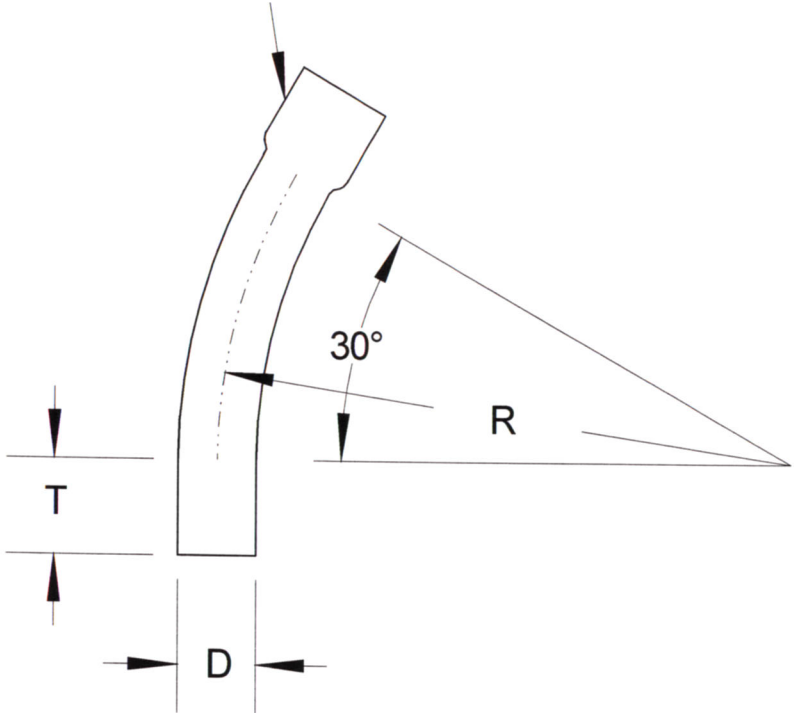

**RACEWAYS TECHNOLOGY
& MFG., INC.**
TACOMA, WA

30 DEGREE C-DUCT PVC ELBOW 60" RADIUS

NO SCALE

RTP

2012