

SIZE	DIAMETER "D"	RADIUS "R"	TANGENT "T" (MIN.)	PART NUMBER	WEIGHT (LBS.)
4"	4.35	36"	3.25	CD-44536	3.689

INTEGRAL COUPLING

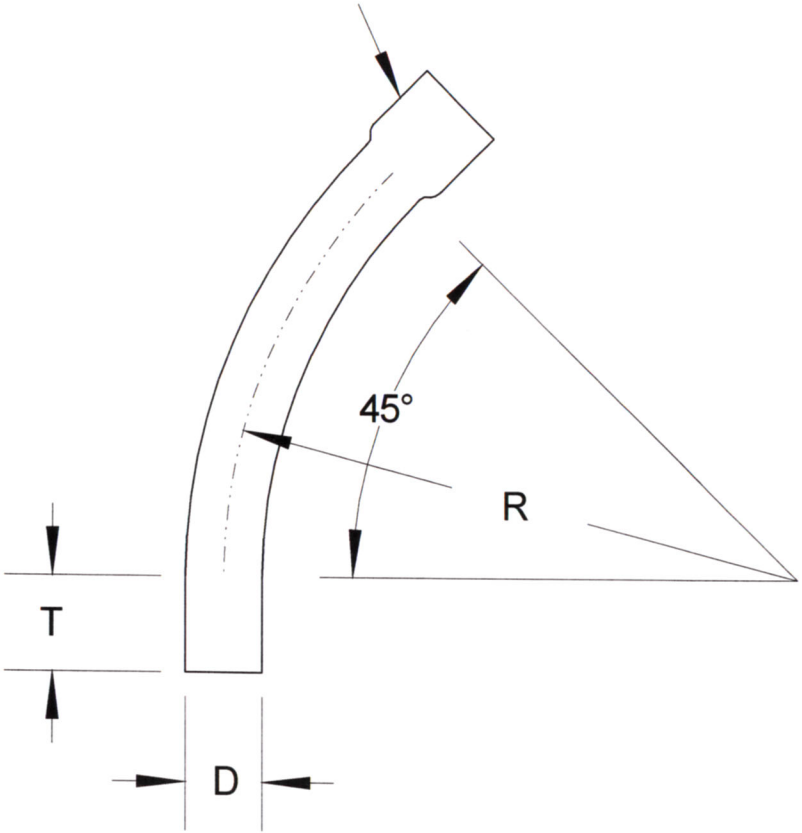

**RACEWAYS TECHNOLOGY
& MFG., INC.**
TACOMA, WA

45 DEGREE C-DUCT PVC ELBOW 36" RADIUS

NO SCALE	RTP	2012
----------	-----	------