

SIZE	DIAMETER "D"	RADIUS "R"	TANGENT "T" (MIN.)	PART NUMBER	WEIGHT (LBS.)
4"	4.35	24"	3.25	CD-49024	4.929

INTEGRAL COUPLING

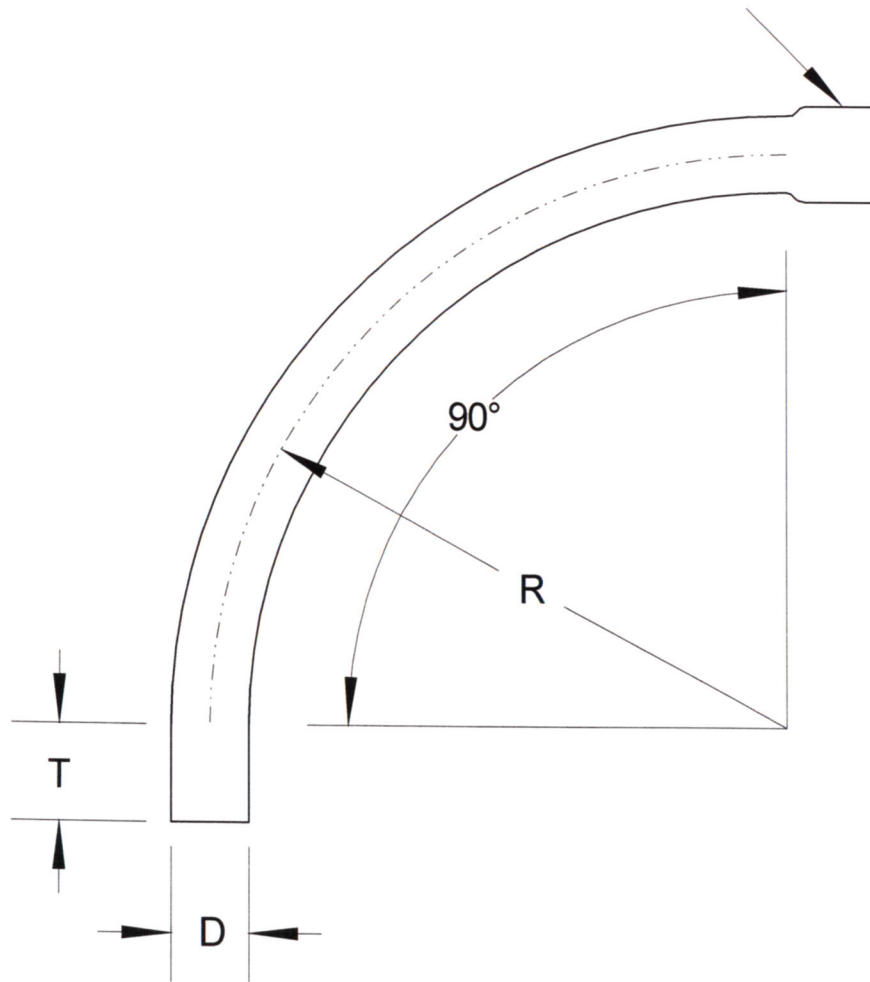

**RACEWAYS TECHNOLOGY  
& MFG., INC.**  
TACOMA, WA

90 DEGREE C-DUCT PVC ELBOW 24" RADIUS

NO SCALE	RTP	2012
----------	-----	------