

SIZE	DIAMETER "D"	RADIUS "R"	TANGENT "T" (MIN.)	PART NUMBER	WEIGHT (LBS.)
1 1/4"	1.66"	18"	2"	S40GS-1251118	0.316
1 1/2"	1.9"	18"	2"	S40GS-1501118	0.378
2"	2.375"	18"	2"	S40GS-21118	0.502
3"	3.5"	18"	3.125"	S40GS-31118	1.349
4"	4.5"	18"	3.375"	S40GS-41118	1.918

INTEGRAL COUPLING

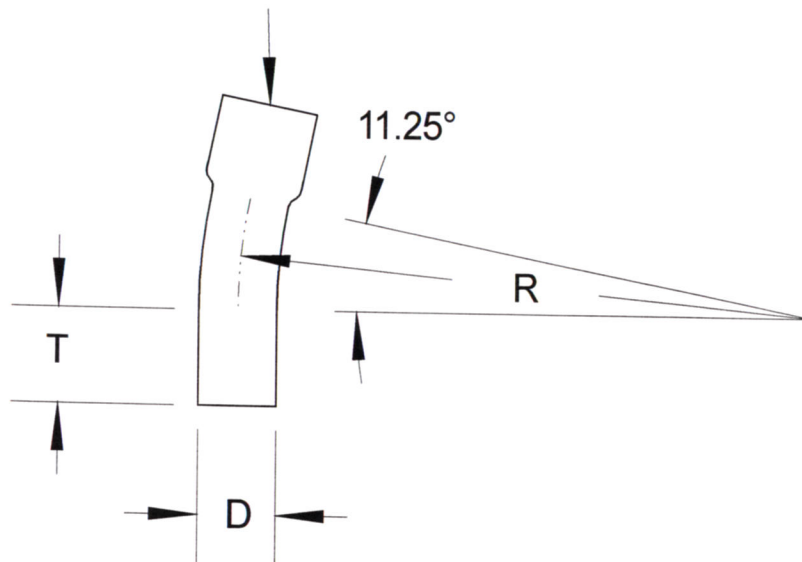

**RACEWAYS TECHNOLOGY
& MFG., INC.**
TACOMA, WA

11.25 DEGREE S/40 GAS PVC ELBOW 18" RADIUS

NO SCALE

RTP

2012