

SIZE	DIAMETER "D"	RADIUS "R"	TANGENT "T" (MIN.)	PART NUMBER	WEIGHT (LBS.)
1 1/4"	1.66"	72"	2"	S40GS-1251172	0.646
1 1/2"	1.9"	72"	2"	S40GS-1501172	0.782
2"	2.375"	72"	2"	S40GS-21172	1.037
3"	3.5"	72"	3.125"	S40GS-31172	2.898
4"	4.5"	72"	3.375"	S40GS-41172	5.431

INTEGRAL COUPLING

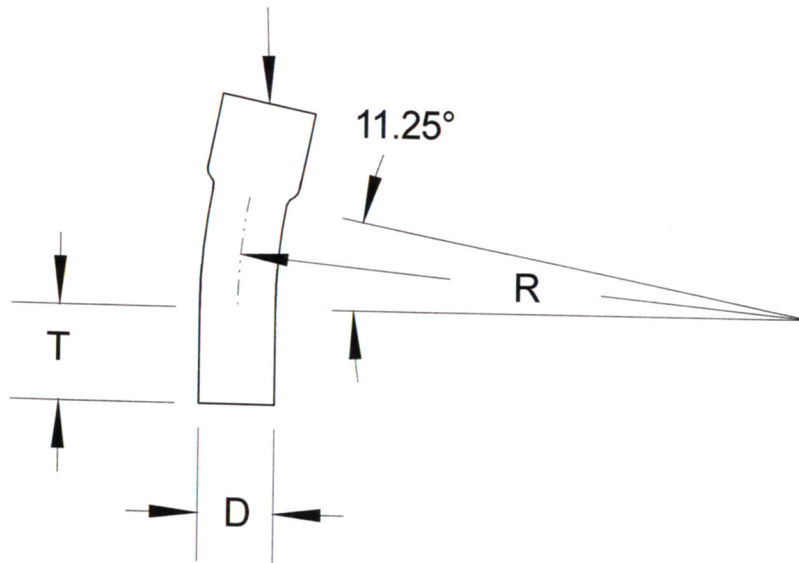

**RACEWAYS TECHNOLOGY
& MFG., INC.**
TACOMA, WA

11.25 DEGREE S/40 GAS PVC ELBOW 72" RADIUS

NO SCALE

RTP

2012