

SIZE	DIAMETER "D"	RADIUS "R"	TANGENT "T" (MIN.)	PART NUMBER	WEIGHT (LBS.)
1 1/4"	1.66"	36"	2"	S40GS-1252236	0.757
1 1/2"	1.9"	36"	2"	S40GS-1502236	0.905
2"	2.375"	36"	2"	S40GS-22236	1.201
3"	3.5"	36"	3.125"	S40GS-32236	2.732
4"	4.5"	36"	3.375"	S40GS-42236	3.884

INTEGRAL COUPLING

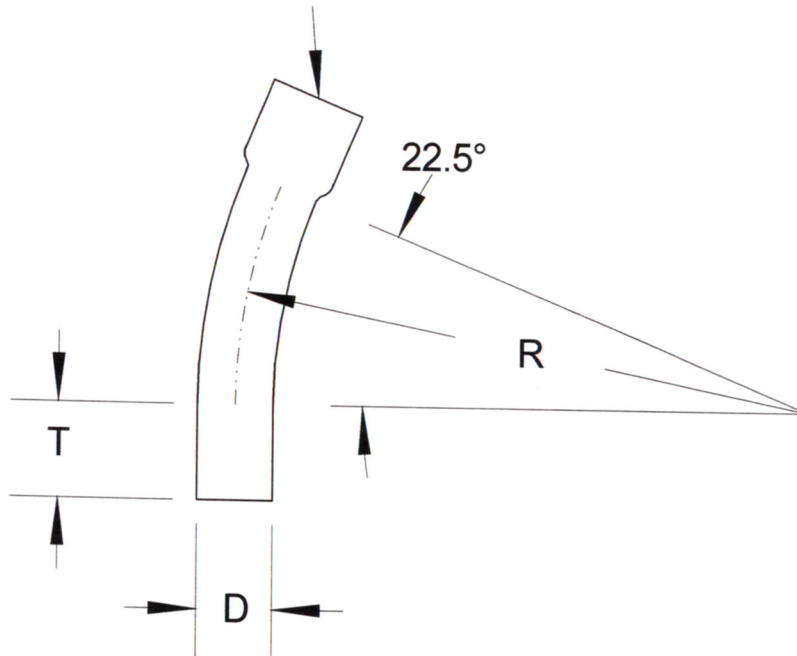

**RACEWAYS TECHNOLOGY
& MFG., INC.**
TACOMA, WA

22.5 DEGREE S/40 GAS PVC ELBOW/36" RADIUS

NO SCALE

RTP

2012