

SIZE	DIAMETER "D"	RADIUS "R"	TANGENT "T" (MIN.)	PART NUMBER	WEIGHT (LBS.)
1 1/4"	1.66"	72"	2"	S40GS-1252272	1.368
1 1/2"	1.9"	72"	2"	S40GS-1502272	1.656
2"	2.375"	72"	2"	S40GS-22272	2.196
3"	3.5"	72"	3.125"	S40GS-32272	4.968
4"	4.5"	72"	3.375"	S40GS-42272	7.092

INTEGRAL COUPLING

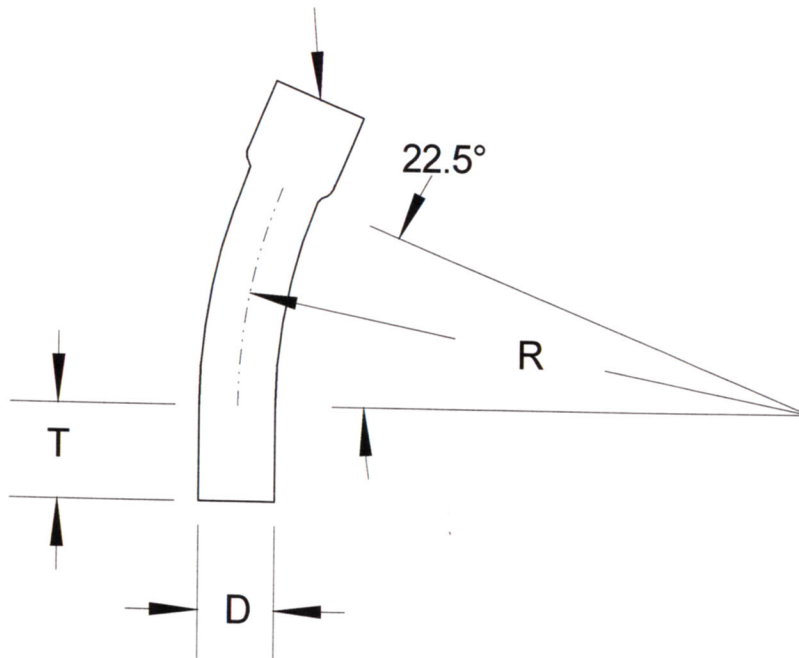

**RACEWAYS TECHNOLOGY
& MFG., INC.**
TACOMA, WA

22.5 DEGREE S/40 GAS PVC ELBOW 72" RADIUS

NO SCALE

RTP

2012