

SIZE	DIAMETER "D"	RADIUS "R"	TANGENT "T" (MIN.)	PART NUMBER	WEIGHT (LBS.)
1 1/4"	1.66"	72"	2"	S40GS-1253072	1.9
1 1/2"	1.9"	72"	2"	S40GS-1503072	2.3
2"	2.375"	72"	2"	S40GS-23072	3.05
3"	3.5"	72"	3.125"	S40GS-33070	6.9
4"	4.5"	72"	3.375"	S40GS-43070	9.85

INTEGRAL COUPLING

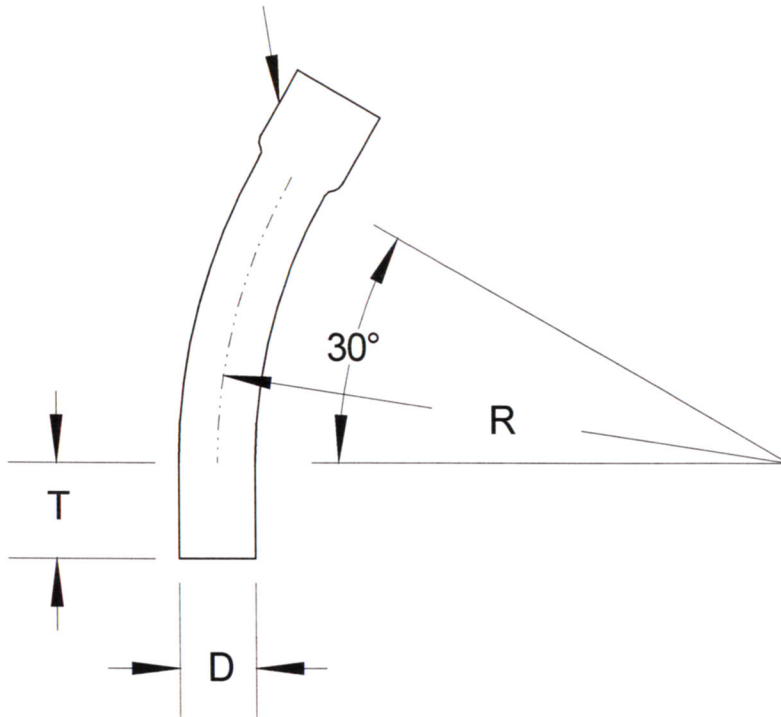

**RACEWAYS TECHNOLOGY
& MFG., INC.**

TACOMA, WA

30 DEGREE S/40 GAS PVC ELBOW 72" RADIUS

NO SCALE

RTP

2012