

SIZE	DIAMETER "D"	RADIUS "R"	TANGENT "T" (MIN.)	PART NUMBER	WEIGHT (LBS.)
1 1/4"	1.66"	36"	2"	S40GS-1254536	1.14
1 1/2"	1.9"	36"	2"	S40GS-1504536	1.364
2"	2.375"	36"	2"	S40GS-24536	1.81
3"	3.5"	36"	3.125"	S40GS-34536	4.115
4"	4.5"	36"	3.375"	S40GS-44536	5.851

INTEGRAL COUPLING

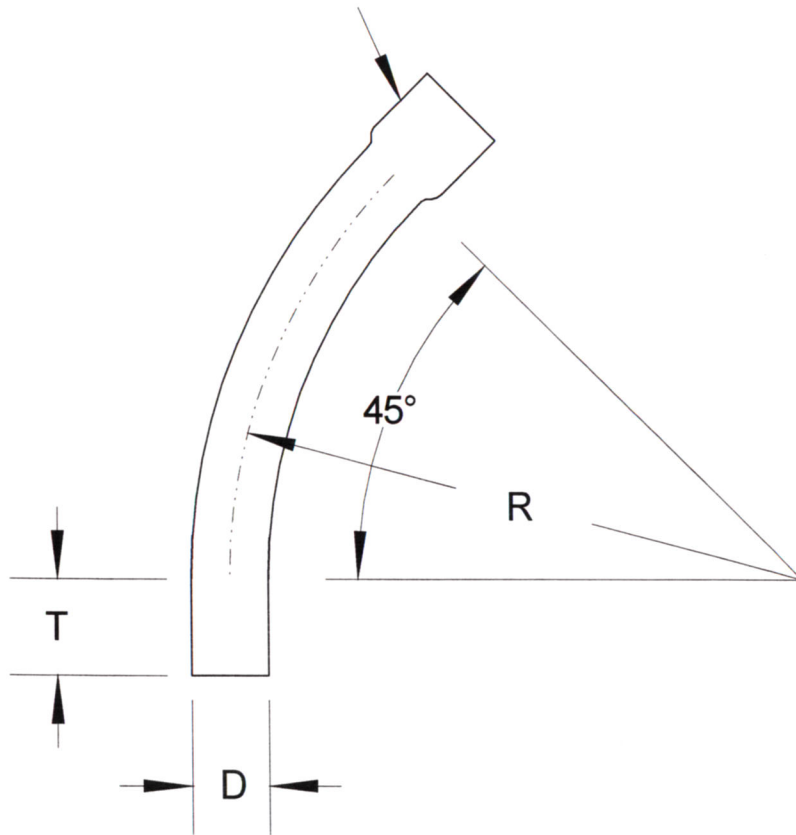

**RACEWAYS TECHNOLOGY
& MFG., INC.**
TACOMA, WA

45 DEGREE S/40 GAS PVC ELBOW 36" RADIUS

NO SCALE

RTP

2012