

SIZE	DIAMETER "D"	RADIUS "R"	TANGENT "T" (MIN.)	PART NUMBER	WEIGHT (LBS.)
1 1/4"	1.66"	36"	2"	S40GS-1259036	2.29
1 1/2"	1.9"	36"	2"	S40GS-1509036	2.739
2"	2.375"	36"	2"	S40GS-29036	3.635
3"	3.5"	36"	3.125"	S40GS-39036	8.265
4"	4.5"	36"	3.375"	S40GS-49036	11.751

INTEGRAL COUPLING

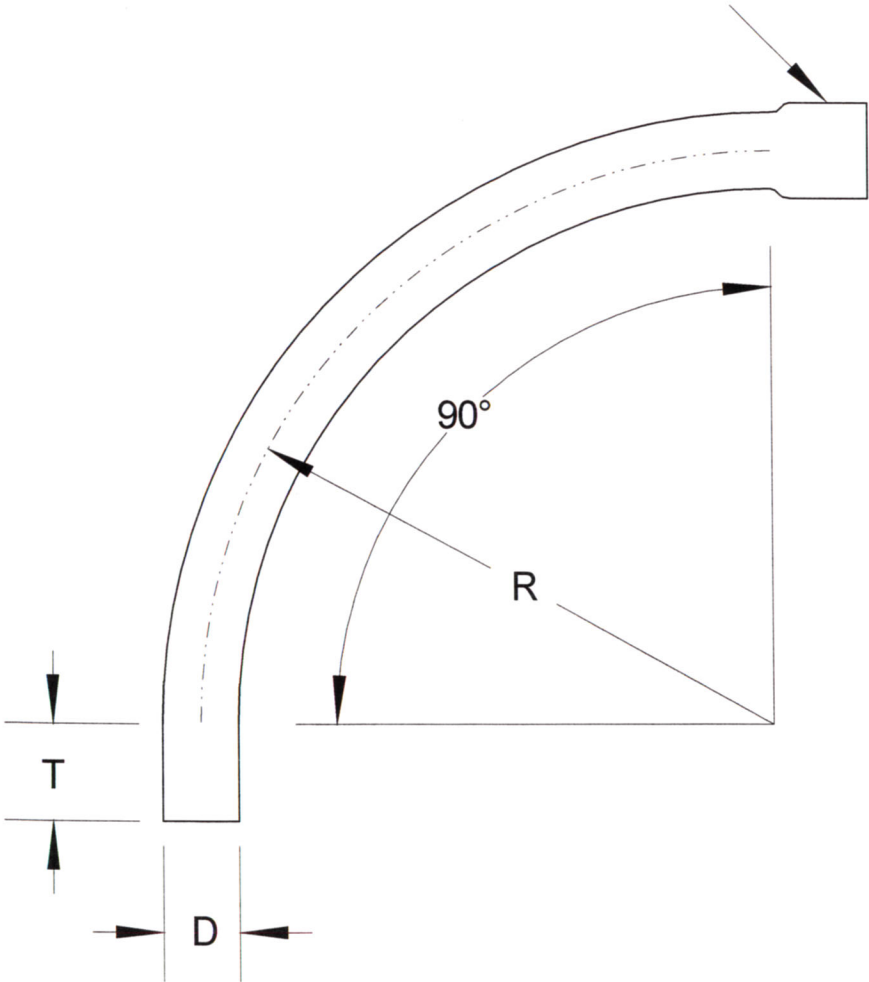

**RACEWAYS TECHNOLOGY
& MFG., INC.**
TACOMA, WA

90 DEGREE S/40 GAS PVC ELBOW 36" RADIUS

NO SCALE

RTP

2012