

SIZE	DIAMETER "D"	RADIUS "R"	TANGENT "T" (MIN.)	PART NUMBER	WEIGHT (LBS.)
1 1/4"	1.66"	60"	2"	S40GS-1259060	3.699
1 1/2"	1.9"	60"	2"	S40GS-1509060	4.446
2"	2.375"	60"	2"	S40GS-29060	5.962
3"	3.5"	60"	3.125"	S40GS-39060	13.833
4"	4.5"	60"	3.375"	S40GS-49060	17.651

INTEGRAL COUPLING

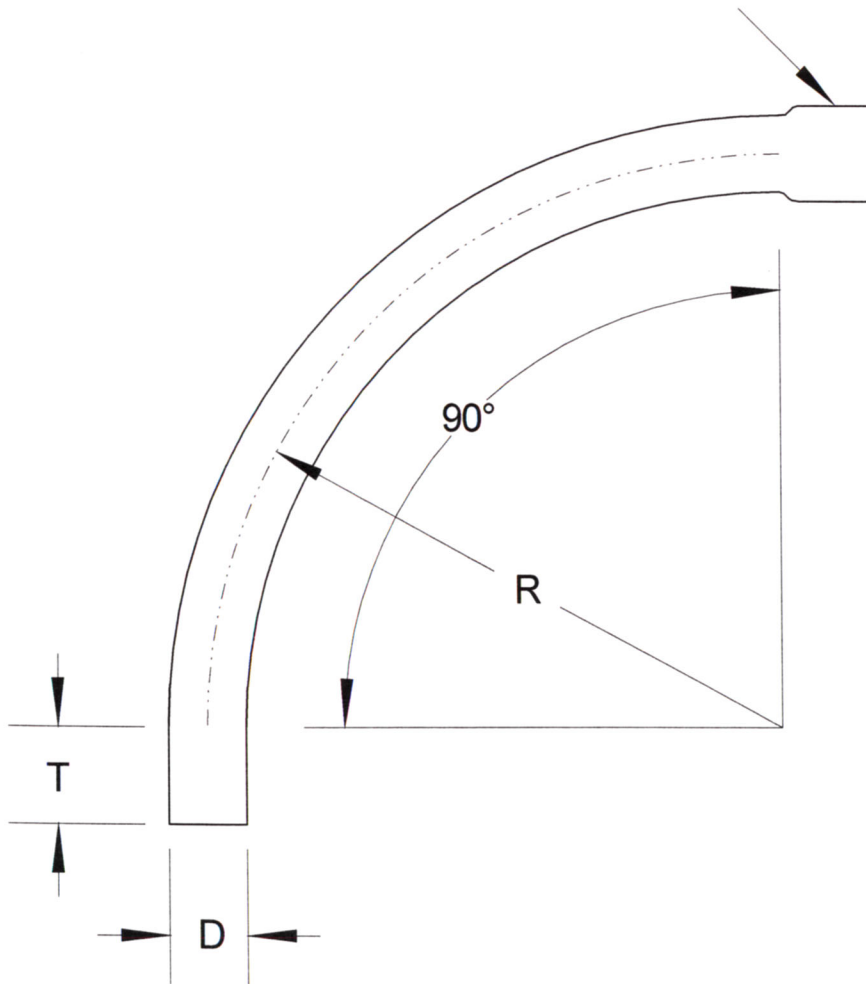

**RACEWAYS TECHNOLOGY
& MFG., INC.**
TACOMA, WA

90 DEGREE S/40 GAS PVC ELBOW 60" RADIUS

NO SCALE

RTP

2012