

SIZE	DIAMETER "D"	RADIUS "R"	TANGENT "T" (MIN.)	PART NUMBER	WEIGHT (LBS.)
1 1/4"	1.66"	72"	2"	S40GS-1259072	4.6
1 1/2"	1.9"	72"	2"	S40GS-1509072	5.5
2"	2.375"	72"	2"	S40GS-29072	7.3
3"	3.5"	72"	3.125"	S40GS-39072	16.6
4"	4.5"	72"	3.375"	S40GS-49072	23.6

INTEGRAL COUPLING

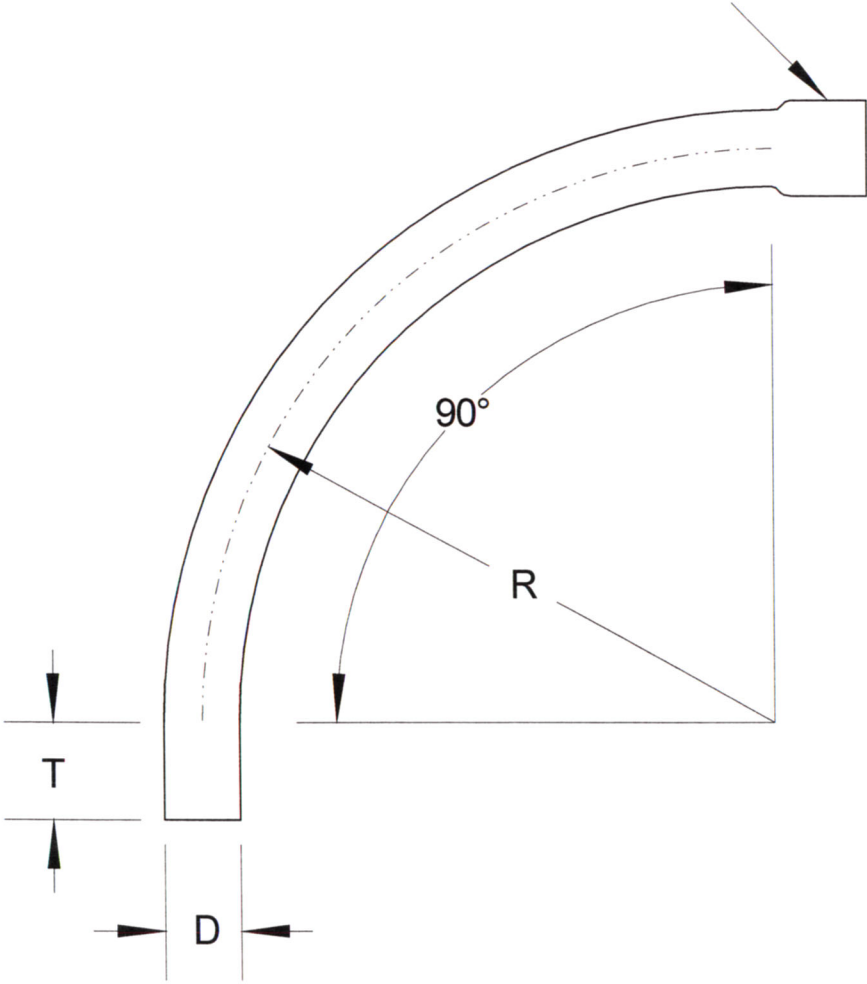

**RACEWAYS TECHNOLOGY  
& MFG., INC.**  
TACOMA, WA

90 DEGREE S/40 GAS PVC ELBOW 72" RADIUS

NO SCALE

RTP

2012