

ALL S/40 CONDUIT ELBOWS AND SWEEPS MANUFACTURED BY RACEWAYS TECHNOLOGY ARE MADE FROM ETL OR UL LISTED PVC PIPE TO UL 651 SPECIFICATIONS.

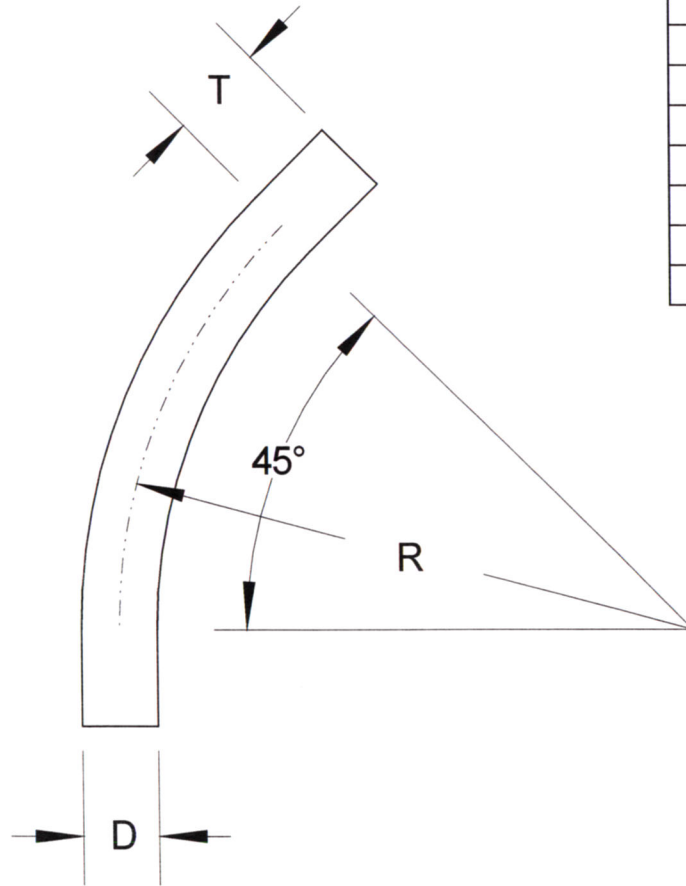

SIZE	DIAMETER "D"	RADIUS "R"	TANGENT "T" (MIN.)	PART NUMBER	WEIGHT (LBS.)
1/2"	.84"	4"	1.5"	S40-0545STD	0.08
3/4"	1.05"	4.5"	1.5"	S40-07545STD	0.114
1"	1.315"	5.75"	1.875"	S40-145STD	0.22
1 1/4"	1.66"	7.25"	2"	S40-12545STD	0.364
1 1/2"	1.9"	8.25"	2"	S40-15045STD	0.481
2"	2.375"	9.5"	2"	S40-245STD	0.715
2 1/2"	2.875"	10.5"	3"	S40-25045STD	0.918
3"	3.5"	13"	3.125"	S40-345STD	2.352
3 1/2"	4"	15"	3.25"	S40-35045STD	3.068
4"	4.5"	16"	3.375"	S40-445STD	3.884
5"	5.563"	24"	3.625"	S40-545STD	7.067
6"	6.625"	30"	3.75"	S40-645STD	11.931
8"	8.625"	44"	6.625"	S40-845STD	27.42

INTEGRAL COUPLINGS AVAILABLE ON REQUEST
INTEGRAL COUPLINGS CONFORM TO UL 651 SPECIFICATIONS

**RACEWAYS TECHNOLOGY
& MFG., INC.**
TACOMA, WA

45 DEGREE S/40 PVC ELBOW STD RADIUS

NO SCALE

RTP

2012