

SIZE	DIAMETER "D"	RADIUS "R"	TANGENT "T" (MIN.)	PART NUMBER	WEIGHT (LBS.)
1/2"	0.84	4"	1.5"	S40W-0590STD	0.131
3/4"	1.05	4.5"	1.5"	S40W-07590STD	0.19
1"	1.315"	5.75"	1.875"	S40W-190STD	0.344
1 1/4"	1.66"	7.25"	2"	S40W-12590STD	0.578
1 1/2"	1.9"	8.25"	2"	S40W-15090STD	0.728
2"	2.375"	9.5"	2"	S40W-290STD	1.1
2 1/2"	2.875"	10.5"	3"	S40W-25090STD	2.072
3"	3.5	13"	3.125"	S40W-390STD	3.124
4"	4.5"	16"	3.375"	S40W-490STD	5.206
5"	5.563"	24"	3.625"	S40W-590STD	10.465
6"	6.625"	30"	3.75"	S40W-690STD	16.56
8"	8.625"	44"	6.625"	S40W-890STD	39.47

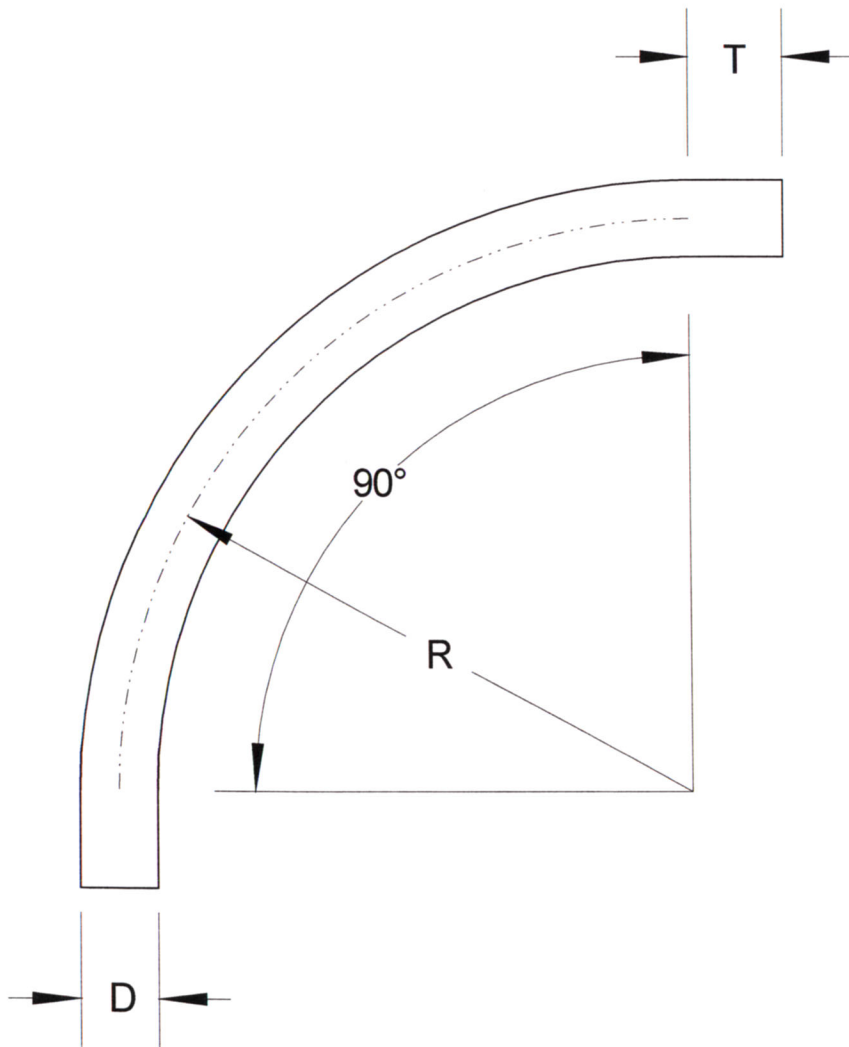

INTEGRAL COUPLINGS AVAILABLE ON REQUEST

**RACEWAYS TECHNOLOGY
& MFG., INC.**
TACOMA, WA

90 DEGREE S/40 NSF PVC ELBOW STD RADIUS

NO SCALE

RTP

2012