

SIZE	DIAMETER "D"	RADIUS "R"	TANGENT "T" (MIN.)	PART NUMBER	WEIGHT (LBS.)
1"	1.315"	48"	1.875"	DB-11148	0.2063
1 1/2"	1.9"	48"	2"	DB-1501148	0.3163
2"	2.375"	48"	2"	DB-21148	0.495
3"	3.5	48"	3.125"	DB-31148	1.2245
4"	4.5"	48"	3.375"	DB-41148	2.1775
5"	5.563"	48"	3.625"	DB-51148	4.646
6"	6.625"	48"	3.75"	DB-61148	6.59

INTEGRAL COUPLING

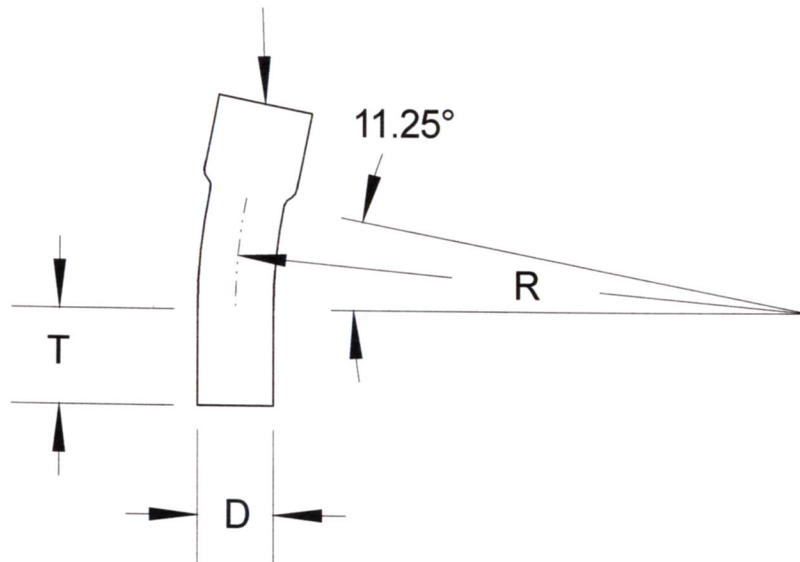

**RACEWAYS TECHNOLOGY
& MFG., INC.**
TACOMA, WA

11.25 DEGREE DB120 PVC ELBOW 48" RADIUS

NO SCALE

RTP

2012