

SIZE	DIAMETER "D"	RADIUS "R"	TANGENT "T" (MIN.)	PART NUMBER	WEIGHT (LBS.)
1"	1.315"	12"	1.875"	DB-12212	0.09
1 1/2"	1.9"	12"	2"	DB-1502212	0.161
2"	2.375"	12"	2"	DB-22212	0.288

INTEGRAL COUPLING

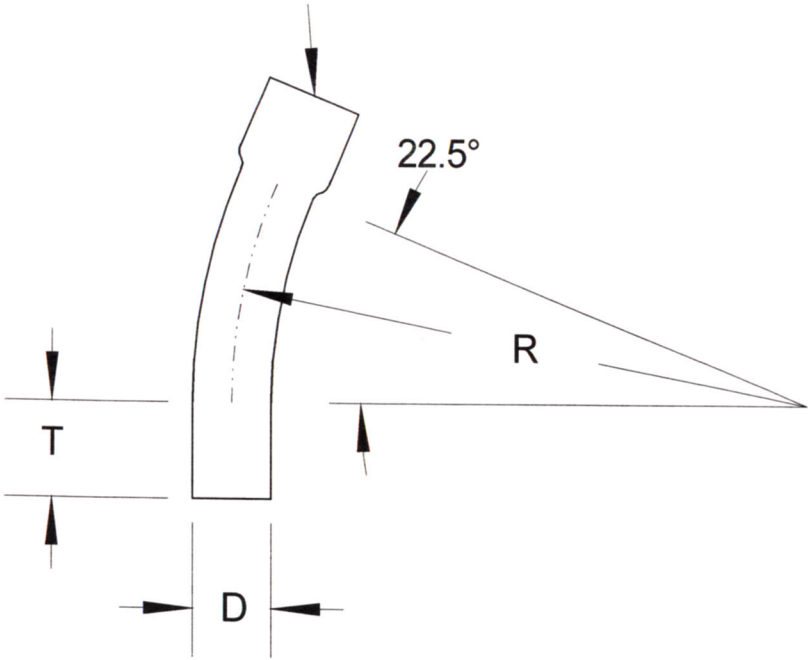

**RACEWAYS TECHNOLOGY
& MFG., INC.**
TACOMA, WA

22.5 DEGREE DB120 PVC ELBOW 12" RADIUS

NO SCALE	RTP	2012
----------	-----	------