

ALL S/80 CONDUIT ELBOWS AND SWEEPS MANUFACTURED BY RACEWAYS TECHNOLOGY ARE MADE FROM ETL OR UL LISTED PVC PIPE TO UL 651 SPECIFICATIONS.

SIZE	DIAMETER "D"	RADIUS "R"	TANGENT "T" (MIN.)	PART NUMBER	WEIGHT (LBS.)
1/2"	.84"	72"	1.5"	S80-059072	2.1
3/4"	1.05"	72"	1.5"	S80-0759072	2.8
1"	1.315"	72"	1.875"	S80-19072	4.2
1 1/4"	1.66"	72"	2"	S80-1259072	5.7
1 1/2"	1.9"	72"	2"	S80-1509072	6.9
2"	2.375"	72"	2"	S80-29072	9.6
2 1/2"	2.875"	72"	3"	S80-2509072	14.6
3"	3.5	72"	3.125"	S80-39072	19.6
4"	4.5"	72"	3.375"	S80-49072	28.6
5"	5.563"	72"	3.625"	S80-59072	39.7
6"	6.625"	72"	3.75"	S80-69072	57.33

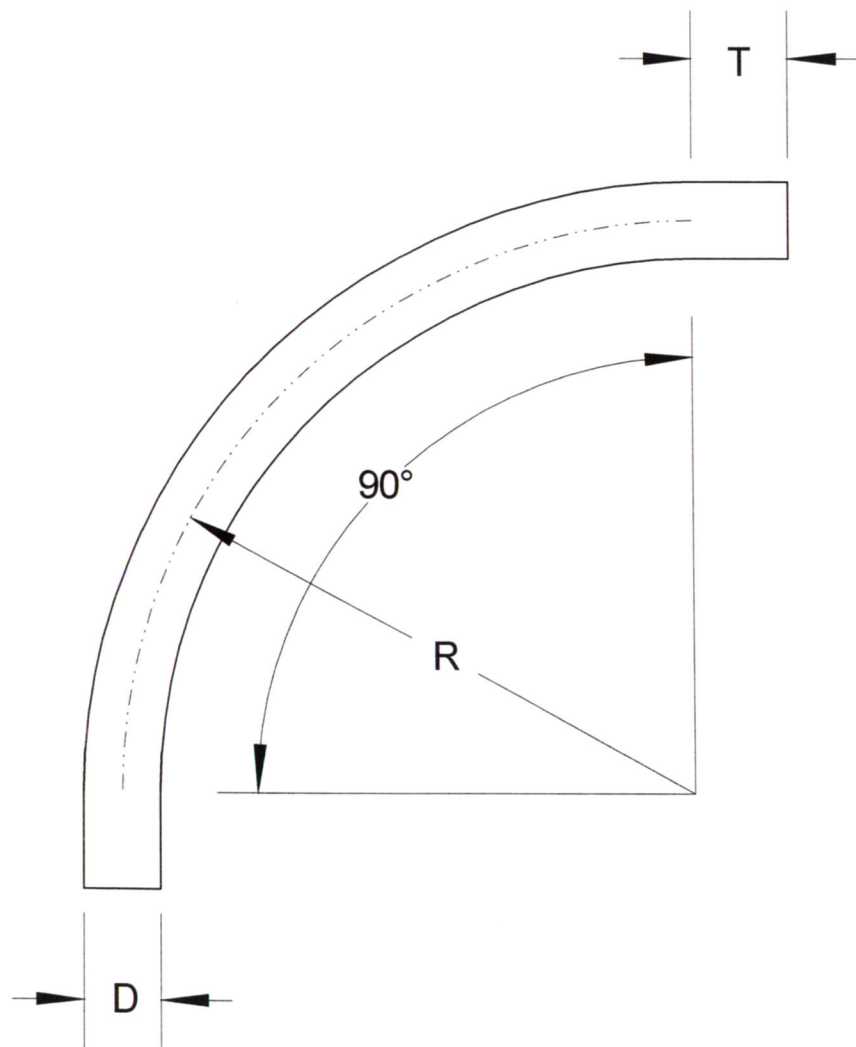

INTEGRAL COUPLINGS AVAILABLE ON REQUEST
INTEGRAL COUPLINGS CONFORM TO UL 651 SPECIFICATIONS

**RACEWAYS TECHNOLOGY
& MFG., INC.**
TACOMA, WA

90 DEGREE S/80 PVC ELBOW 72" RADIUS

NO SCALE

RTP

2012