

SIZE	DIAMETER "D"	RADIUS "R"	TANGENT "T" (MIN.)	PART NUMBER	WEIGHT (LBS.)
2"	2.375"	72"	2"	S40B-23072	17.3

INTEGRAL COUPLING

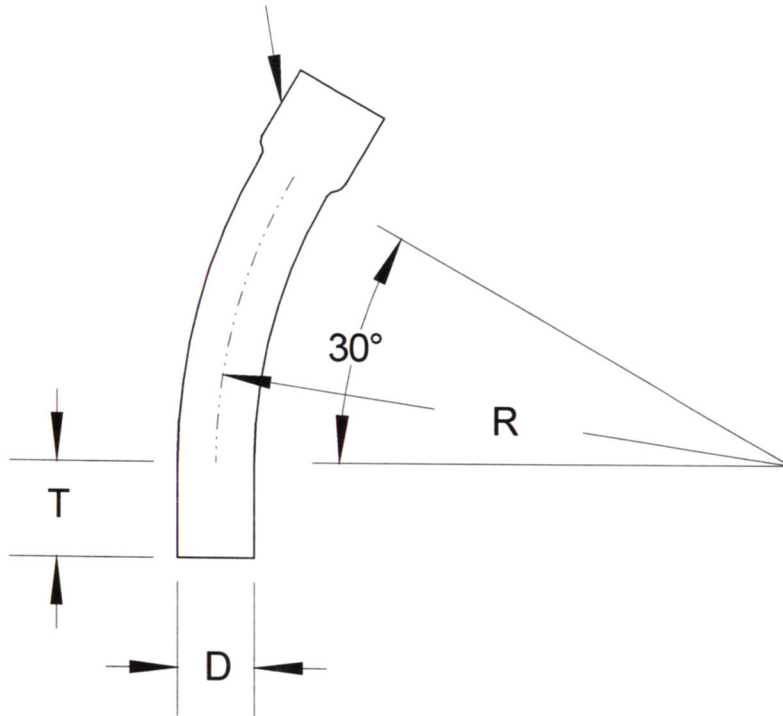

**RACEWAYS TECHNOLOGY
& MFG., INC.**
TACOMA, WA

30 DEGREE S40 BUFF PVC ELBOW 72" RADIUS

NO SCALE

RTP

2012