

SIZE	DIAMETER "D"	RADIUS "R"	TANGENT "T" (MIN.)	PART NUMBER	WEIGHT (LBS.)
2"	2.375"	12"	2"	S40B-29012	2.296

INTEGRAL COUPLING

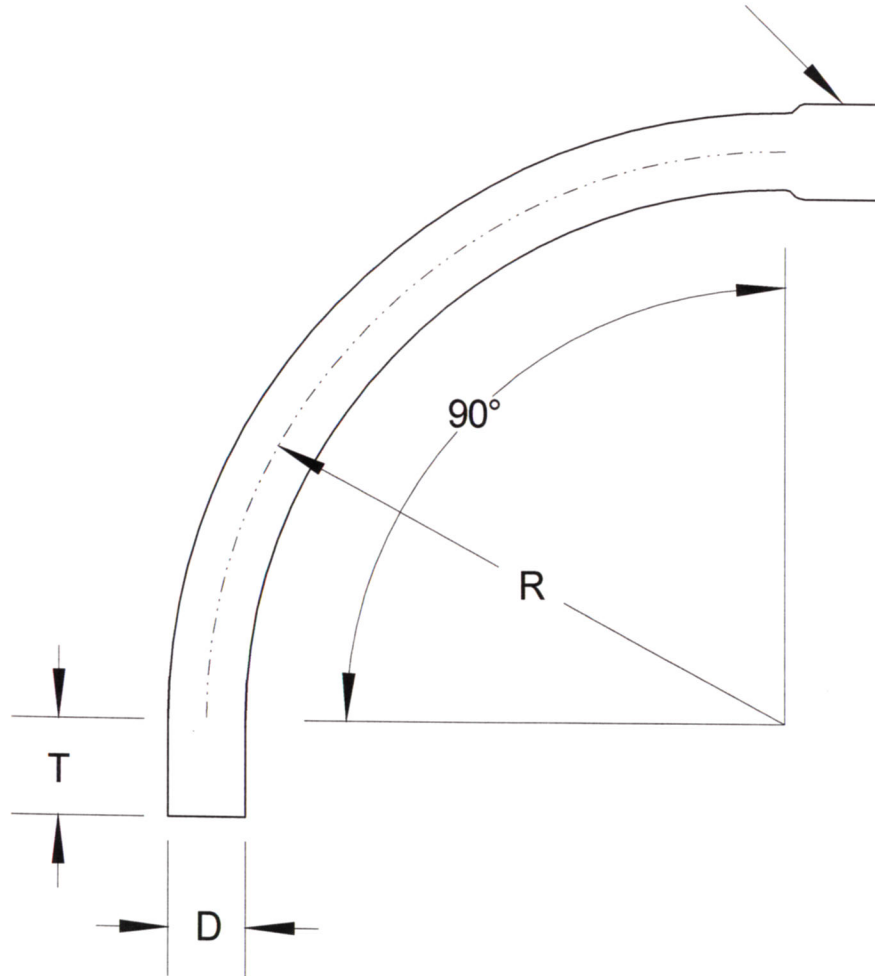

**RACEWAYS TECHNOLOGY
& MFG., INC.**
TACOMA, WA

90 DEGREE S/40 BUFF PVC ELBOW 12" RADIUS

NO SCALE

RTP

2012