

SIZE	DIAMETER "D"	RADIUS "R"	TANGENT "T" (MIN.)	PART NUMBER	WEIGHT (LBS.)
4"	4.35	48"	3.25	CD-43048	3.596

INTEGRAL COUPLING

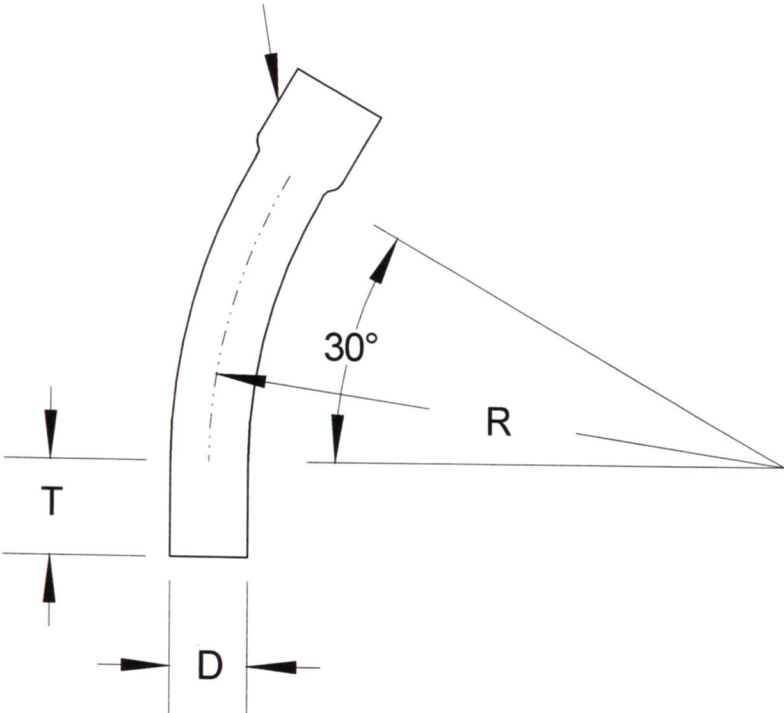

**RACEWAYS TECHNOLOGY
& MFG., INC.**
TACOMA, WA

30 DEGREE C-DUCT PVC ELBOW 48" RADIUS

NO SCALE	RTP	2012
----------	-----	------