

SIZE	DIAMETER "D"	RADIUS "R"	TANGENT "T" (MIN.)	PART NUMBER	WEIGHT (LBS.)
1 1/4"	1.66"	12"	2"	S40GS-1252212	0.249
1 1/2"	1.9"	12"	2"	S40GS-1752212	0.321
2"	2.375"	12"	2"	S40GS-22212	0.487
3"	3.5"	12"	3.125"	S40GS-32212	1.66
4"	4.5"	12"	3.375"	S40GS-42212	2.753

INTEGRAL COUPLING

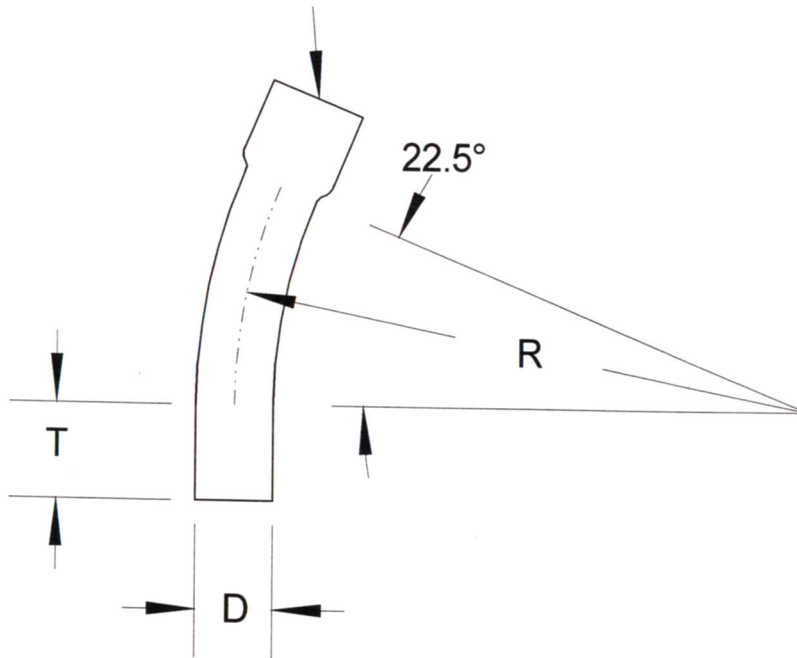

**RACEWAYS TECHNOLOGY  
& MFG., INC.**  
TACOMA, WA

22.5 DEGREE S/40 GAS PVC ELBOW 12" RADIUS

NO SCALE

RTP

2012