

SIZE	DIAMETER "D"	RADIUS "R"	TANGENT "T" (MIN.)	PART NUMBER	WEIGHT (LBS.)
1 1/4"	1.66"	24"	2"	S40GS-1252224	0.345
1 1/2"	1.9"	24"	2"	S40GS-1502224	0.413
2"	2.375"	24"	2"	S40GS-22224	0.548
3"	3.5"	24"	3.125"	S40GS-32224	1.383
4"	4.5"	24"	3.375"	S40GS-42224	1.967

INTEGRAL COUPLING

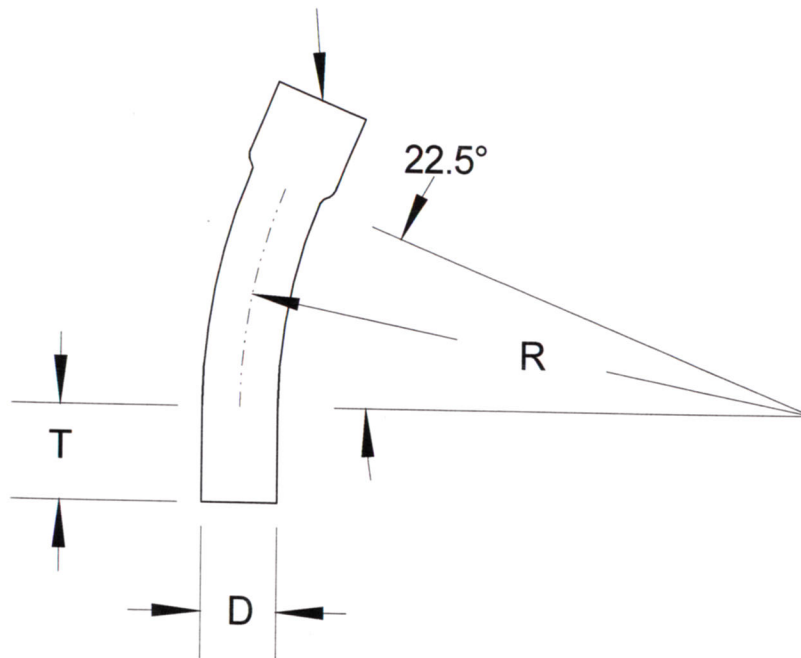

**RACEWAYS TECHNOLOGY
& MFG., INC.**
TACOMA, WA

22.5 DEGREE S/40 GAS PVC ELBOW/24" RADIUS

NO SCALE

RTP

2012