

SIZE	DIAMETER "D"	RADIUS "R"	TANGENT "T" (MIN.)	PART NUMBER	WEIGHT (LBS.)
1 1/4"	1.66"	48"	2"	S40GS-1252248	0.91
1 1/2"	1.9"	48"	2"	S40GS-1502248	1.089
2"	2.375"	48"	2"	S40GS-22248	1.445
3"	3.5"	48"	3.125"	S40GS-32248	3.285
4"	4.5"	48"	3.375"	S40GS-42248	4.671

INTEGRAL COUPLING

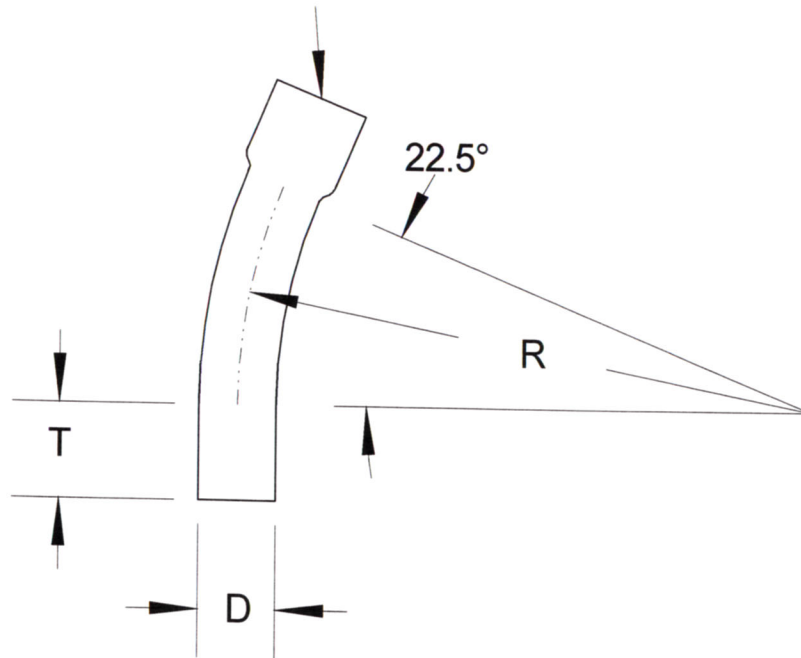

**RACEWAYS TECHNOLOGY
& MFG., INC.**
TACOMA, WA

22.5 DEGREE S/40 GAS PVC ELBOW 48" RADIUS

NO SCALE

RTP

2012