

SIZE	DIAMETER "D"	RADIUS "R"	TANGENT "T" (MIN.)	PART NUMBER	WEIGHT (LBS.)
1 1/4"	1.66"	36"	2"	S40GS-1253036	0.882
1 1/2"	1.9"	36"	2"	S40GS-1503036	1.054
2"	2.375"	36"	2"	S40GS-23036	1.399
3"	3.5"	36"	3.125"	S40GS-33036	3.285
4"	4.5"	36"	3.375"	S40GS-43036	3.939

INTEGRAL COUPLING

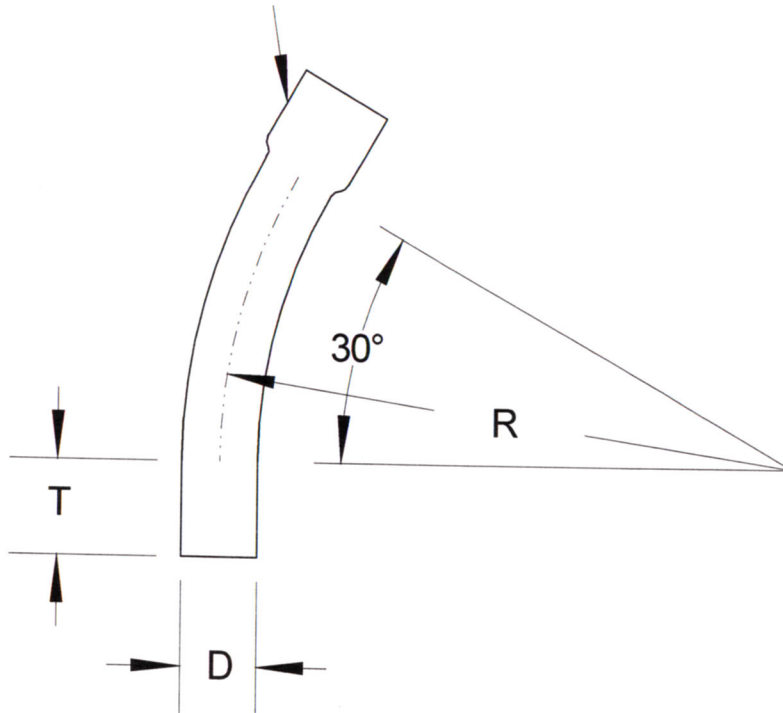

**RACEWAYS TECHNOLOGY
& MFG., INC.**

TACOMA, WA

30 DEGREE S/40 GAS PVC ELBOW/36" RADIUS

NO SCALE

RTP

2012