

SIZE	DIAMETER "D"	RADIUS "R"	TANGENT "T" (MIN.)	PART NUMBER	WEIGHT (LBS.)
1 1/4"	1.66"	48"	2"	S40GS-1254548	1.524
1 1/2"	1.9"	48"	2"	S40GS-1504548	1.822
2"	2.375"	48"	2"	S40GS-24548	2.418
3"	3.5"	48"	3.125"	S40GS-34548	5.499
4"	4.5"	48"	3.375"	S40GS-44548	7.818

INTEGRAL COUPLING

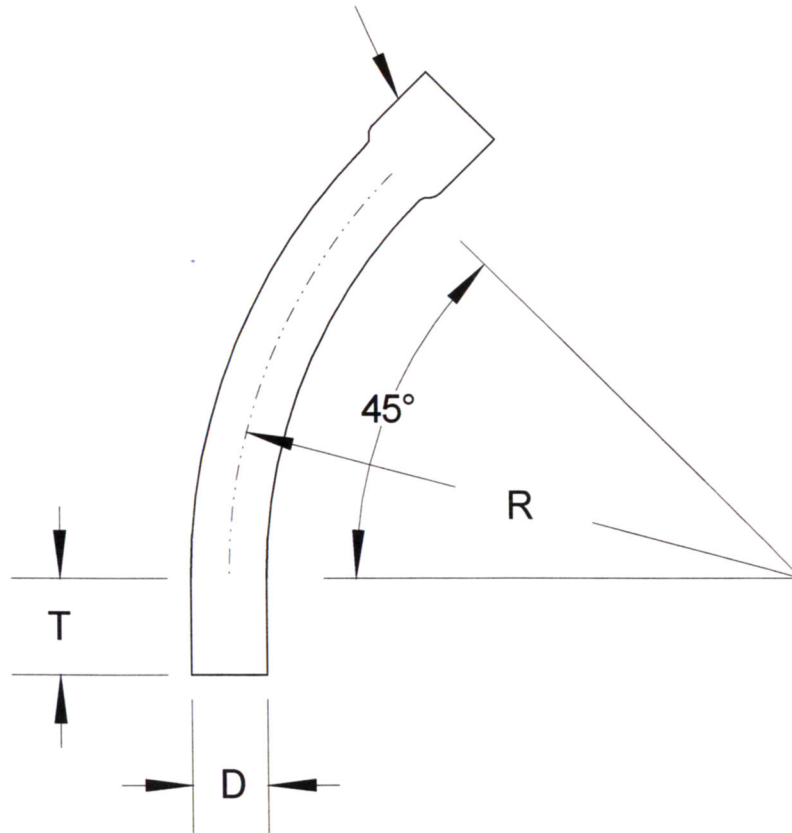

**RACEWAYS TECHNOLOGY  
& MFG., INC.**

TACOMA, WA

45 DEGREE S/40 GAS PVC ELBOW 48" RADIUS

NO SCALE

RTP

2012