

SIZE	DIAMETER "D"	RADIUS "R"	TANGENT "T" (MIN.)	PART NUMBER	WEIGHT (LBS.)
1 1/4"	1.66"	18"	2"	S40GS-1259018	1.14
1 1/2"	1.9"	18"	2"	S40GS-1509018	1.364
2"	2.375"	18"	2"	S40GS-29018	1.81
3"	3.5"	18"	3.125"	S40GS-39018	4.115
4"	4.5"	18"	3.375"	S40GS-49018	6.883

INTEGRAL COUPLING

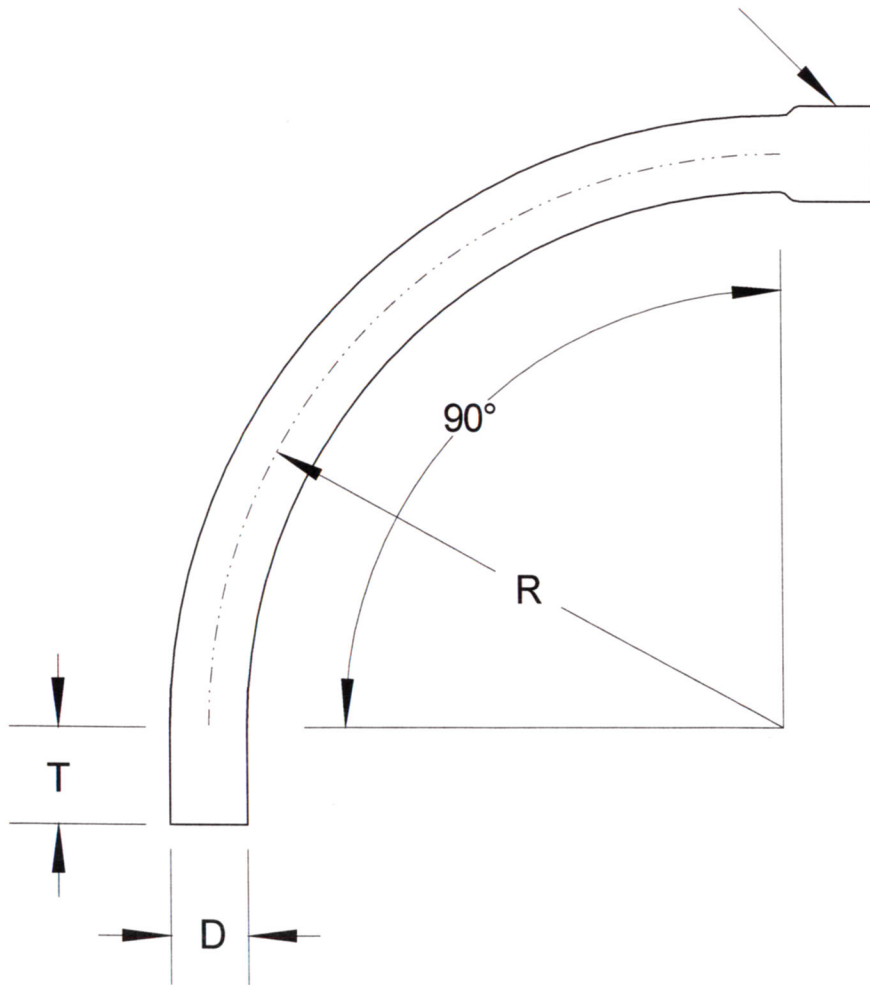

**RACEWAYS TECHNOLOGY  
& MFG., INC.**  
TACOMA, WA

90 DEGREE S/40 GAS PVC ELBOW 18" RADIUS

NO SCALE

RTP

2012