

SIZE	DIAMETER "D"	RADIUS "R"	TANGENT "T" (MIN.)	PART NUMBER	WEIGHT (LBS.)
1/2"	0.84	4"	1.5"	S40W-0530STD	0.098
3/4"	1.05	4.5"	1.5"	S40W-07530STD	0.126
1"	1.315"	5.75"	1.875"	S40W-130STD	0.193
1 1/4"	1.66"	7.25"	2"	S40W-12530STD	0.275
1 1/2"	1.9"	8.25"	2"	S40W-15030STD	0.345
2"	2.375"	9.5"	2"	S40W-230STD	0.565
2 1/2"	2.875"	10.5"	3"	S40W-25030STD	0.989
3"	3.5	13"	3.125"	S40W-330STD	1.715
4"	4.5"	16"	3.375"	S40W-430STD	2.8
5"	5.563"	24"	3.625"	S40W-530STD	4.493
6"	6.625"	30"	3.75"	S40W-630STD	7.36
8"	8.625"	44"	6.625"	S40W-830STD	18.36

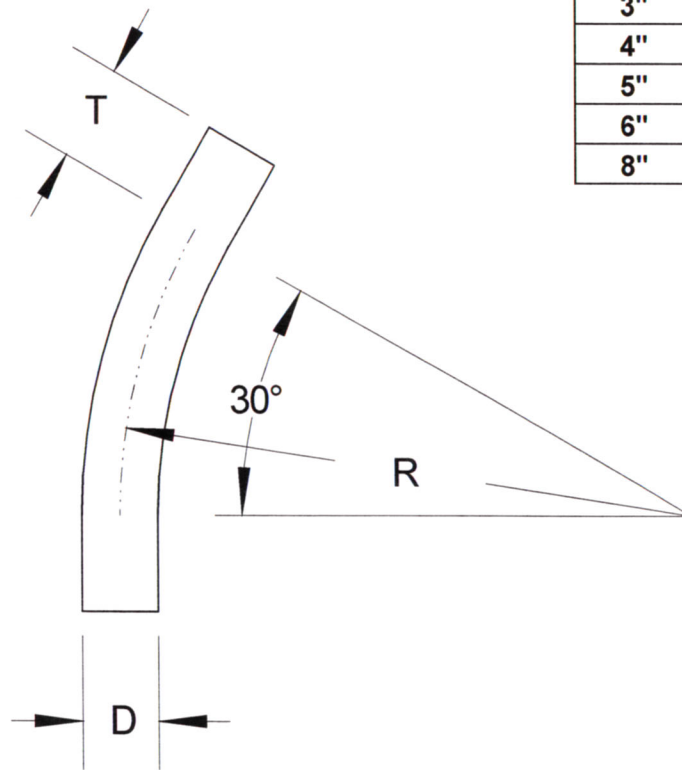

INTEGRAL COUPLINGS AVAILABLE ON REQUEST

**RACEWAYS TECHNOLOGY  
& MFG., INC.**

TACOMA, WA

30 DEGREE S/40 NSF PVC ELBOW STD RADIUS

NO SCALE

RTP

2012